



ALL SEASONS  
ALL COMFORT

**TIVOLI**

RETRACTABLE BIOCLIMATIC PERGOLA

*Transforms spaces into  
living concepts.*

**LUXIAL**  
OUTDOOR LIVING SYSTEMS



## TIVOLI RETRACTABLE

Tivoli Açılır Biyoklimatik Pergolalar, tam otomatik akıllı lamelleri sayesinde terasınızdaki gölgelendirmeyi ayarlayabilir. Güneş ışınlarından doğrudan tam korunma, istenildiği kadar güneş ışınına izin verme ve tam açıklık seçenekleri sunar. Açıldığında doğal ortam sıcaklığının düzenlenmesini, tamamen kapatıldığında ise suya dayanıklı tam kapalı bir ortam oluşturmanızı sağlar.

Oteller, müstakil evler, restoranlar, barlar ve birinci sınıf eğlence mekanlarında kullanım için ideal seçenektir. İhtiyaçlarınız doğrultusunda farklı varyasyonlar sunar. Mevcut mekanınızın mimarisine uyartılabilir veya bağımsız kendini taşıyabilen kurulum varyasyonları sağlanabilir. Kurulum kolaylığı sağlayan özel tasarımı yalnızca bir günde montajının tamamlanmasına olanak sağlar. Alüminyum ve paslanmaz çelikten oluşan malzemeleriyle zamanın olumsuzluklarına karşı uzun yıllar dayanıklıdır.

Yenilikçi ve benzersiz diğer Luxial ürünleriyle entegre olarak rahat bir dış mekan yaşam alanı yaratma esnekliği sağlar. Soğuk ve rüzgarı dışarıda tutarak iç ortam sıcaklığınızı dengeler.

*Tivoli Retractable Bioclimatic Pergolas can adjust the shading on your terrace thanks to their fully automatic smart fins. It offers full protection from direct sunlight, allowing as much sunlight as desired and full opening. It enables the regulation of the natural ambient temperature when opened, and creates a fully enclosed water-resistant environment when fully closed.*

*It is the ideal choice for use in hotels, private homes, residences, restaurants, bars and world-class entertainment venues. It offers different variations according to your needs. It can be adapted to the architecture of your existing space or independently self-supporting installation variations can be provided. Its special design that provides ease of installation allows the assembly to be completed in just one day. With its aluminum and stainless-steel material, it is resistant to the adversities of time for many years.*

*It provides the flexibility to create a comfortable outdoor living space by integrating with other innovative and unique Luxial products. It balances your indoor temperature by keeping the cold and wind out.*



Kapalı Sistem  
Closed System



Yarı Açık Sistem  
Semi-Open System



Açık Sistem  
Open System

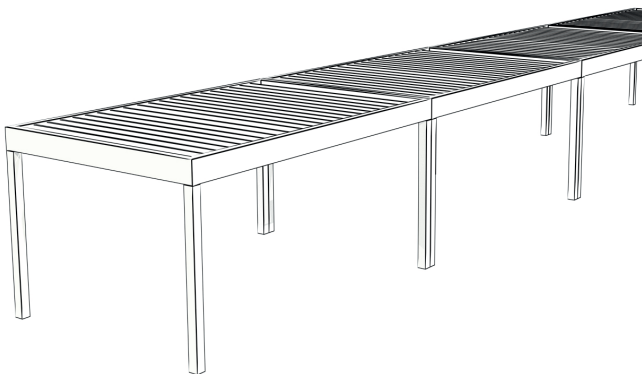



Lamel ölçüsü 278 mm x 40 mm.  
Maksimum lamel uzunluğu 4000 mm.

Blade dimensions 278 mm x 40 mm.  
Max blade length 4000 mm.



Ağırlık 35 ≈ kg/m<sup>2</sup>

Weight 35 ≈ kg/m<sup>2</sup>



Materyal // 6063 T5 alüminyum,  
paslanmaz çelik ve delrin.

Materials // 6063 T5 aluminum,  
stainless steel and delrin.

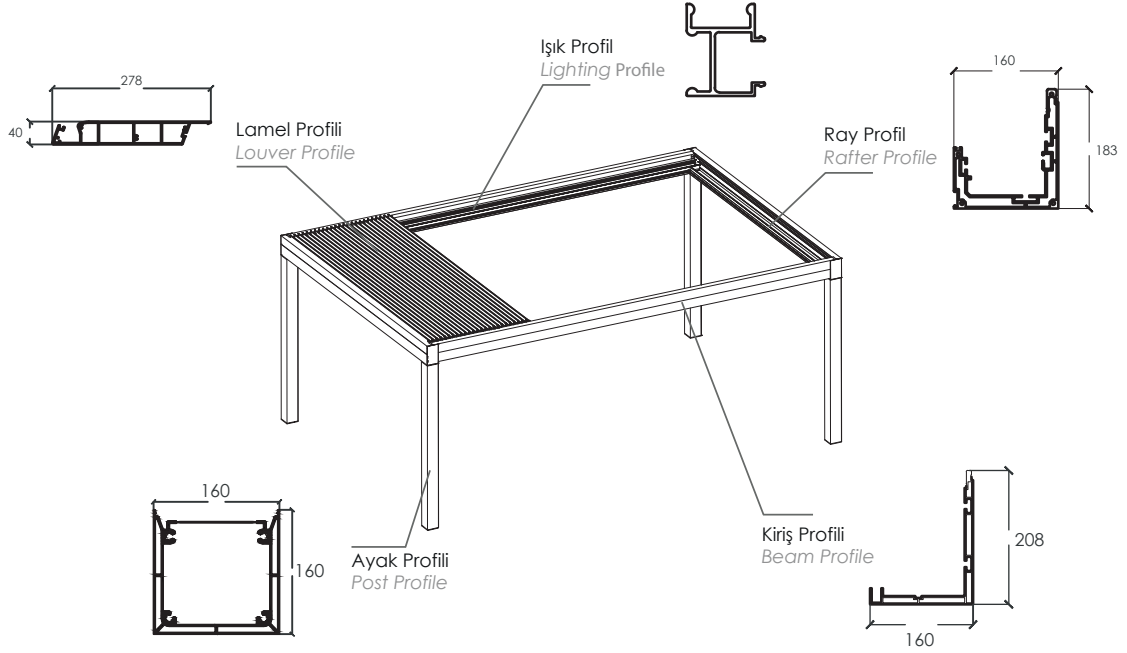

1<sup>st</sup> CLASS  
ALUMINIUM SYSTEMS



RAL Renk Seçimi  
RAL renk standardına göre  
seçtiğiniz tüm renkler uygulanabilir.

RAL Color Selection  
Coloring of your choice, according  
to the RAL color standard.



Motörlü Sistem  
Motörlü sistem ve uzaktan kumanda  
kontrolü.

Electrical Motion  
Capability of electrical motion and  
remote control.



Yağmurlu hava koşullarına, kar  
suyuna ve rüzgâra karşı büyük  
direnç.

Great resistance to weather  
conditions of rain, snow, humidity  
and wind.

#### Rüzgâr Yüküne Dayanım Testi

Standart UNE-EN 13659:2004 Class 6 // 112 km/h  
normlarına göre test edilmiştir. herhangi bir kırılma  
tespit edilmemiştir.

#### Kar Yüküne Dayanım Testi

Standart EN-1999 EUROCODE 9 // 100 kg / m<sup>2</sup> (kendi  
ağırlığı dahil) alüminyum yapılar projesi

#### Yağmur Testi

Standart UNE-EN 12056-3 // (0.03 l/s maks.) Sabit ağır  
yağmur yaklaşık 108 l.m<sup>2</sup>/sa (yapılar + çitalar)

#### Yüzey

10 yıl garantili yüzey kaplaması.

#### Wind Load Resistance Test

UNE-EN 13659: 2004 Class 6 // (approx. 112 km / h)  
not tested up to  
190 km / h. No breakage was detected.

#### Snow Load Resistance Test

Standard EN-1999 EUROCODE 9 // 100 kg / m<sup>2</sup>  
(including its own weight) aluminum structures  
project

#### Rain Test

Standard UNE-EN 12056-3 // (0.03 l/s max) Fixed  
heavy rain approx. 108 l.m<sup>2</sup>/h (structures + lamels)

#### Finishes

10 years of warranty for finishes.

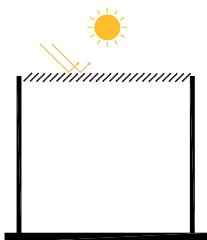

Güneş ışınlarından  
korur

Protection from the  
sun

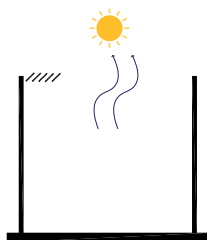

Doğal Havalandırma  
sağlar

Natural ventilation

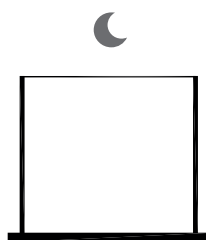

Isı kontrolü sağlar

Adjusting of  
temperature

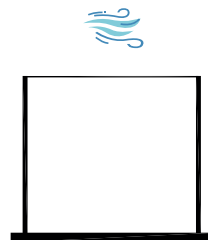

Rüzgâra karşı  
dirençlidir

Stability in wind

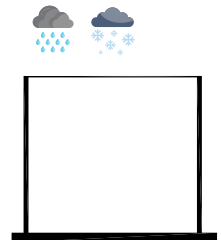

Yağmura ve kara karşı  
tam koruma

Perfect protection from  
rain and snow

# LUXIAL

part of SARAY



## LUXIAL YAPI SİSTEMLERİ

Greenist Ofisleri Yenibosna Merkez Mah. Yalçın Koreş Cad. No: 14/1  
34197 Bahçelievler - İstanbul / TÜRKİYE  
T: +90 212 438 57 90 F: +90 212 438 59 47  
[www.luxial.com](http://www.luxial.com)

